

22" Outdoor Digital Advertising Displays



Fully integrated stunning tablet-style displays; perfect for any weather conditions

Direct Sunlight Readable

Thanks to their commercial grade ultra-high brightness panels (2,000cd/m²), these displays are up to 10 times brighter than a domestic TV and so are easily readable even in direct sunlight.



2,000cd/m²

Weatherproof











Designed to withstand the elements, these displays are protected against all wet weather conditions and airborne dust particles by their robust IP65 rated enclosure. They also feature a waterproof coating on all internal circuit boards and waterproof over-moulded AV connectors.



IP65

- 6** Dust Resistance
Protected against dust that may harm equipment.
- 5** Water Resistance
Protected against water spray from all directions.



-  Vandal Proof
-  Advanced Temperature Control System
-  Anti-Reflective Glass
-  Ambient Light Sensor
-  Protective UV Film
-  Landscape or Portrait
-  Plug and Play
-  Vandal Proof Wi-Fi Aerial
-  24/7 Usage
-  Customisation Available

Other Features

Vandal Proof

With a mild steel enclosure and thermally-toughened glass front, these IK10 rated displays are designed to withstand any damage that may occur in public spaces. To avoid tampering, controls and inputs are hidden and cannot be accessed by passers-by.

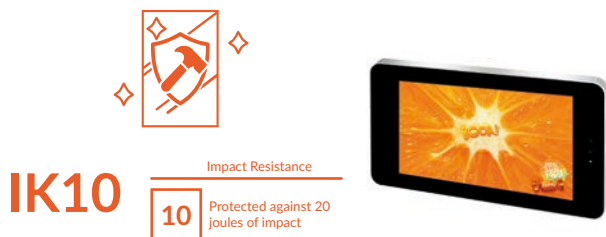

Advanced Temperature Control System

To maximise the lifespan of the display, the internal airflow system keeps the screen running at the optimal temperature regardless of the external conditions. Built-in air conditioning can be tailored to allow the display to work in any climate.

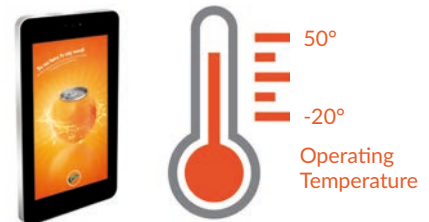

Anti Reflective Glass

The front glass face is specially treated to help diffuse direct sunlight, making the display easily readable even in bright weather conditions.



Ultimate UV Protection

The front glass of the display utilises a special UV treatment that reduces the internal heat of the enclosure by up to 71%; reducing the number of cooling fans needed and increasing the life of your display.



Optional Network Upgrade

The integrated Android media player allows you to easily update on-screen content via USB plug and play. Alternatively, upgrade your screen to be networked without needing any additional hardware to unlock our cloud-based CMS software. Third-party software can be installed instead if required.



Internal Locker

Should you need run the screen from an external source, there is space to fit a small PC or media player inside the lockable compartment. This can then be connected to the display via the HDMI, VGA or 3.5mm audio inputs.



Free Lockable Wall Mount

To ensure that this a complete turnkey solution, a lockable wall mount is included at no extra cost, allowing you to securely mount your screen in either landscape or portrait orientation.



Customisation Available

Bespoke displays can be manufactured to order should you require a non-standard solution, to incorporate a camera or touch screen upgrade for example. We can also modify existing models to add a 4G module for mobile connectivity or a vinyl logo/wrap.

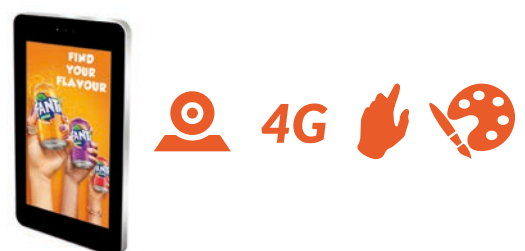

Key Features



2,000 CD/M²
SUNLIGHT READABLE



IP65 RATED



IK10 RATED



VANDAL PROOF HIGH GAIN
WI-FI AERIAL



ANDROID MEDIA PLAYER



PROTECTIVE UV FILM



24/7 USAGE



LANDSCAPE OR PORTRAIT
ORIENTATION



INTERNAL LOCKER

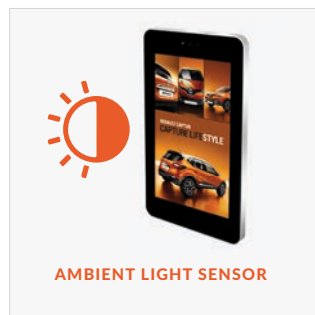

AMBIENT LIGHT SENSOR

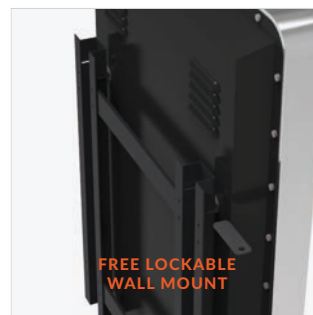

FREE LOCKABLE
WALL MOUNT

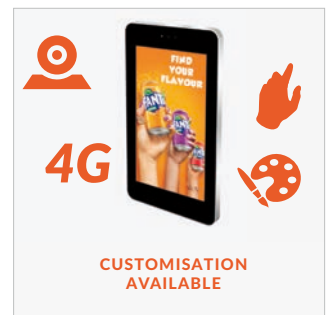

4G

CUSTOMISATION
AVAILABLE

Specification Table

		22 Inch
Panel	Resolution	1920x1080
	Display Area (mm)	477x270
	Aspect Ratio	16:9
	Brightness (cd/m ²)	2,000
	Colour	16.7 M
	Viewing Angle	178°
	Contrast Ratio	8000:1
AV Inputs	Video	HDMI, VGA (Internal)
Power	Power Consumption (W)	130
	Input Voltage	AC110~240V (50Hz~60Hz)
Mechanical	Unit Size (HxWxD mm)	737x397x120
	Package Size (HxWxD mm)	860x560x280
	Landscape VESA Holes (mm)	250x250
	Portrait VESA Holes (mm)	
	Net Weight (kg)	22
	Gross Weight (kg)	27
	IK Rating	IK10
Environmental	Operating Temperature:	-20 °C to 50 °C
	Operating Humidity:	10% - 80%
	Storage Temperature:	-30°C - 60°C
	Storage Humidity:	5% - 90%
	Enclosure Protection	IP65
Media Formats	Video (MPG, AVI, MP4, RM, RMVB, TS), Audio (MP3, WMA), Image (JPG, GIF, BMP, PNG)	
Media Resolution	1920x1080/1080x1920	
Internal Memory	6GB	
CPU	Quad-Core Cortex-A17@1.61GHz	
GPU	Mali-T760 MP4 @600MHz	
RAM	2GB DDR3	
Internal Storage	8GB NAND	
USB	USB2.0 HOST (x2)	
LAN	10/100/1000Mb/s Ethernet	
Wi-Fi	802.11b/g/n/ac	
OS	Android 5.1.1	
Graphic Engine	OpenGL ES 1.1/2.0/3.0/3.1, OpenCL 1.1, Renderscript, Direct3D 11.1	
Accessories	Included	AC Power Cable, Remote Control, Wall Mount
	Optional	Touch Screen Upgrade, Network Upgrade, Camera
Warranty	Warranty Period	3 Year Warranty
	Technical Support	Lifetime

Errors and omissions excepted

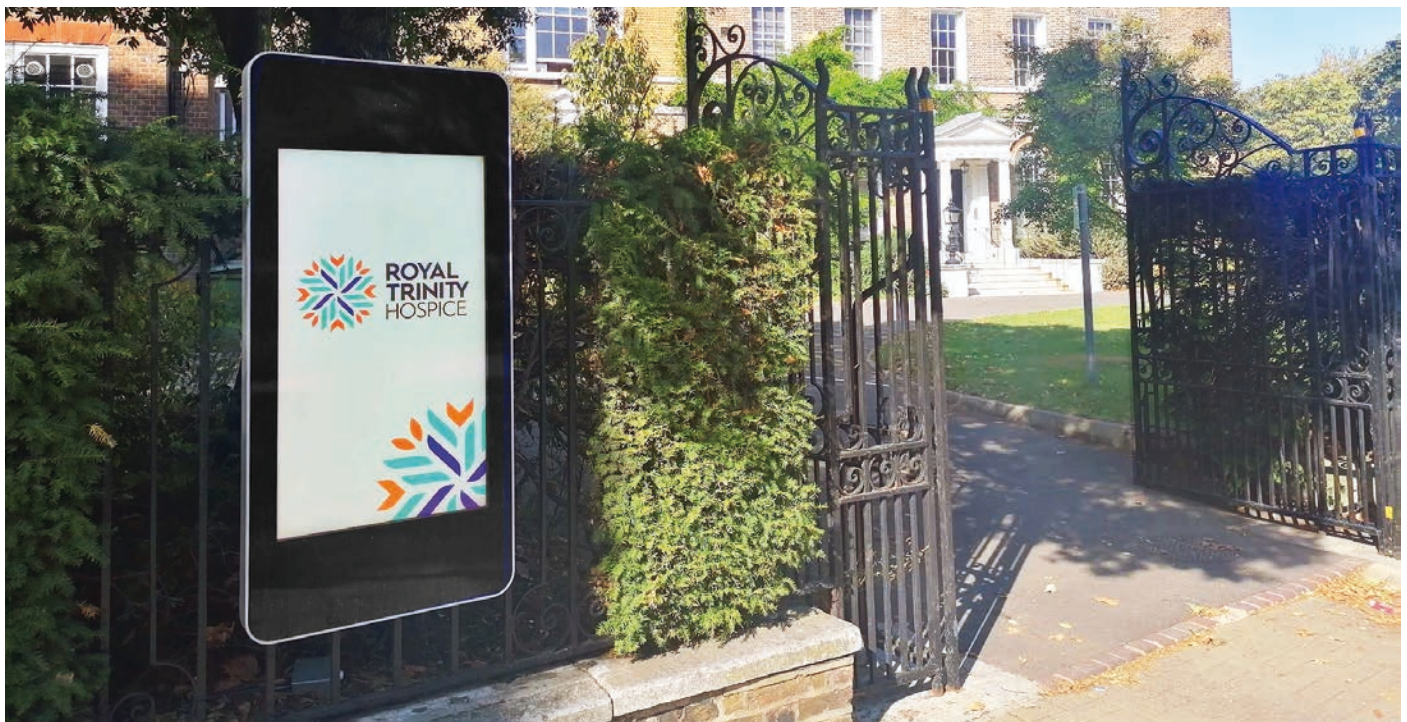

Bracket

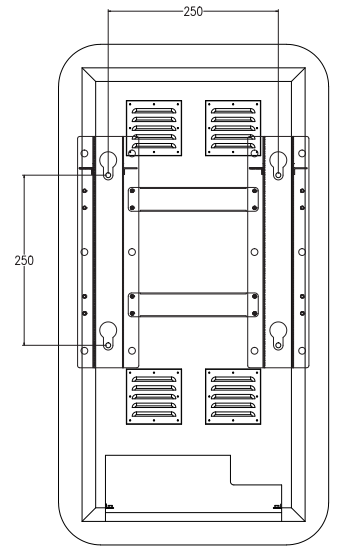
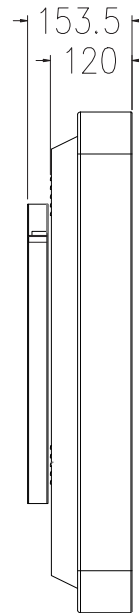
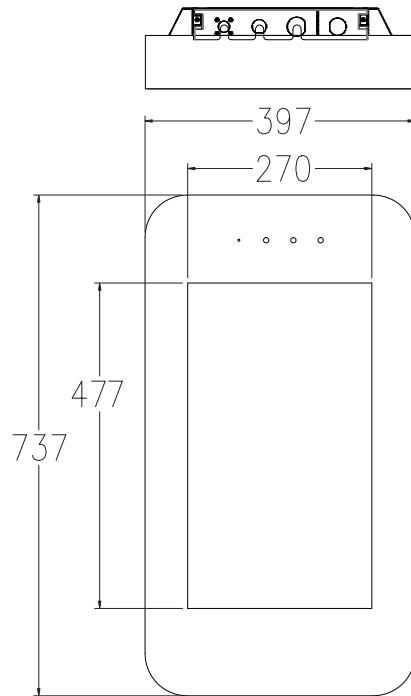
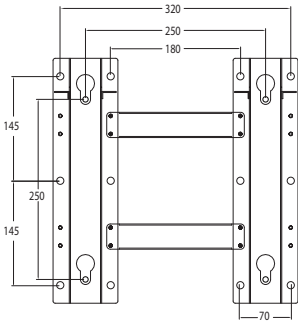

Why Choose Our Commercial Display Solutions?



Lifetime Technical Support

From the moment you receive your product, throughout the duration of your warranty and even after your warranty has expired we are here to support you. If you require any assistance setting up or using your product, or have any problems at all, we can provide free technical support via telephone and email.



On-site Support and Maintenance*

If needed, we can provide an installation service for any of our products. We can also set up service-level agreements for larger projects that require maintenance contracts.



Extended Warranty*

All of our commercial display products come with a 3 year commercial warranty as standard but if you want to extend this you can upgrade this to cover a 5 year period at point of purchase.



Training

As well as providing free remote CMS training sessions and webinars we can also visit you to deliver bespoke training for our software and hardware*.



Advanced Replacements†

Should your display suffer from any kind of hardware failure during the warranty period we will send you an advanced replacement and arrange for your old display to be collected, free of charge. This ensures no downtime where you are without a screen.



Custom Product Testing & Configuration

If you need us to test third party software or a website, or configure your screen in a particular way before it is dispatched (e.g. in a particular orientation or network mode), we can do so to make your life easier.



3D Rendering

Want to know how a particular screen will look once installed? Send us a photo of the location and we will create a 3D rendering of any screen in situ to help you to visualise how amazing it will look.



Logistics Support

We hold more stock in our UK warehouse than any other manufacturer so we can help you meet tight deadlines. For last minute orders we can also offer special express or morning delivery options*. We also carry out UK based quality control checks on every display before it leaves our warehouse.



Project Support

If you need to loan a sample unit to test we'd be more than happy to arrange this. We can also provide a rental service for temporary projects*.



Customisation*

Your display can be customised to suit your requirements by adding your logo or printed graphics or even tailoring the colour of a display. We can also carry out hardware modifications to existing products or manufacture bespoke solutions for special projects.



Extras*

As well as being able to provide accessories and add-ons, such as extra remote controls, NUC PCs and video wall controllers, we can also supply custom made flight cases which are great if a display needs to be moved safely from place to place.

†UK mainland only

*These particular services may incur additional charges